

DASH RIDE

676-006010443060v1

DASH RIDE INSERT SYSTEM SPOTLIGHT made of aluminium, black, similar to RAL 9005, high-efficiently vacuum deposited aluminium reflector beam 60°, light output direct, swiveling 350°, tilting 90°, with converter, max. 350mA, dimmable not dimmable, through wiring 0,75mm², IP20



DRAWING

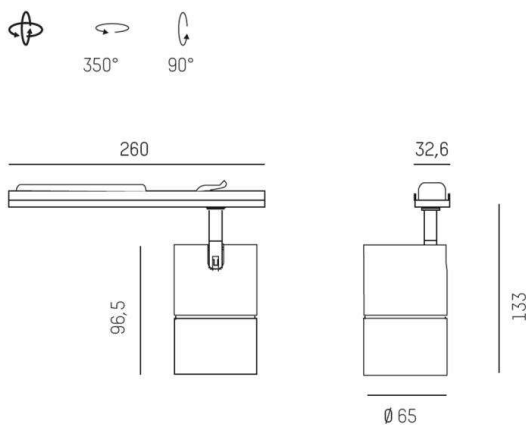

LIGHT DISTRIBUTION CURVE

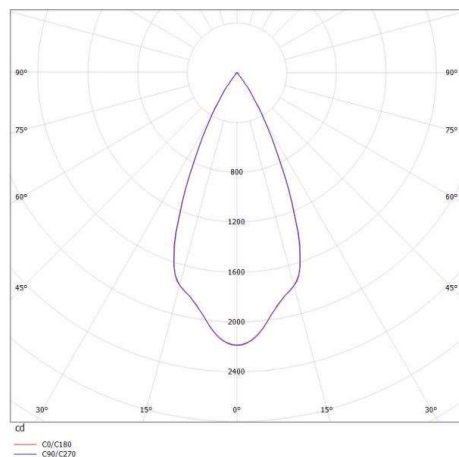

TECHNICAL DETAILS

System perform. [W]	14
Bulb type	LED
Luminous flux [lm]	1220
Current sec. [mA]	350
Colour temp. [K]	2700K
CRI	PREMIUM>90
Optics	vacuum deposited aluminium reflector
Designer	INHOUSE
Converter	with converter
Dimming	nicht dimmbar
Light output	direct
Beam angle [°]	60°
Voltage [V]	220-240V 50/60Hz
Through wiring	0,75mm ²
Material	aluminium

Length [mm]	260
Width [mm]	32,5
Height [mm]	95
Diameter [mm]	65
IP protection class	IP20
Voltage class	protection cl. I
Net weight [kg]	0,56

Color lamp	black
RAL	9005
EAN-Number	9010506098952
Lifetime [h]	L80 B10 50 000



The values are rated values. Power and luminous flux are initially subject to a tolerance of +/- 10%. Colour temperature tolerance: +/- 150 K. The values apply to an ambient temperature of 25°C unless otherwise specified.