

TRIGGA

662-013020523550v1

TRIGGA W WALL / CEILING LUMINAIRE made of aluminium, white matt, similar to RAL 9016, anti-glare LFO lens due to microfaceted structure beam 55°, light output direct, swiveling 350°, tilting 70°, with converter, max. 350mA, dimmable not dimmable, IP20 incl. on-off switch



DRAWING

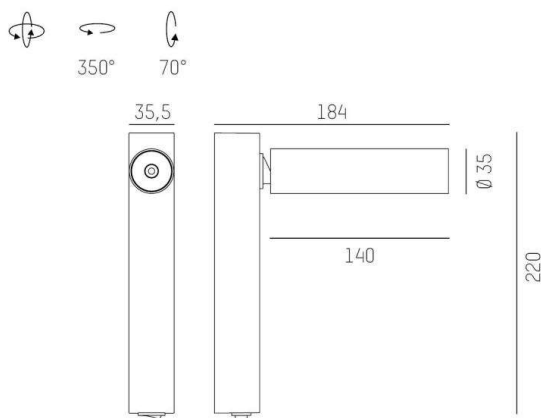

LIGHT DISTRIBUTION CURVE

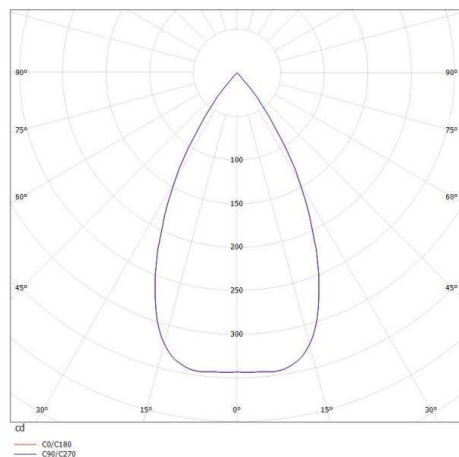

TECHNICAL DETAILS

System perform. [W]	6
Bulb type	LED
Luminous flux [lm]	270
Current sec. [mA]	350
Colour temp. [K]	2700K
CRI	>90
Optics	LFO lens
Designer	Serge & Robert Cornelissen
Converter	with converter
Dimming	nicht dimmbar
Light output	direct
Beam angle [°]	55°
Voltage [V]	220-240V 50/60Hz
Material	aluminium
Width [mm]	35,5
Height [mm]	184
Diameter [mm]	35
IP protection class	IP20
Voltage class	protection cl. II
Net weight [kg]	0,55
Color lamp	white matt
RAL	9016
EAN-Number	9010506345940
Lifetime [h]	L80 B10 50 000
No. of luminaires B16A	27



The values are rated values. Power and luminous flux are initially subject to a tolerance of +/- 10%. Colour temperature tolerance: +/- 150 K. The values apply to an ambient temperature of 25°C unless otherwise specified.