

TRIGGA

662-006020223550

TRIGGA R RECESSED SPOTLIGHT made of aluminium, white matt, similar to RAL 9016, anti-glare LFO lens due to microfaceted structure beam 30°, light output direct, UGR <16, swiveling 350°, tilting 30°, without converter, max. 500mA, IP20



DRAWING

 1 - 20mm

 68 mm, ET 65mm

 350° 30°

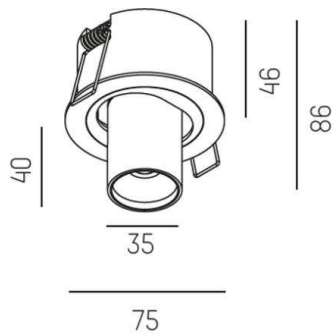

LIGHT DISTRIBUTION CURVE

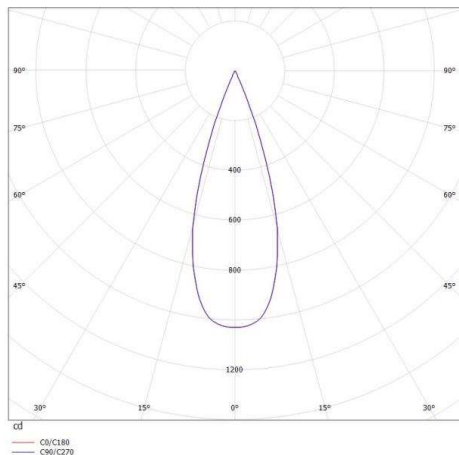

TECHNICAL DETAILS

Bulb type	LED 6W
Luminous flux [lm]	300
Current sec. [mA]	500
Colour temp. [K]	2700K
CRI	>90
UGR	<16
Optics	LFO lens
Designer	Serge & Robert Cornelissen
Converter	without converter
Light output	direct
Beam angle [°]	30°
Material	aluminium

Length [mm]	140
Height [mm]	86
Diameter [mm]	75
Ceiling cutout [mm]	68
Ceiling thickness [mm]	1 - 20mm
Recess depth [mm]	65
IP protection class	IP20
Voltage class	protection cl. II
Net weight [kg]	0,33

Color lamp	white matt
RAL	9016
EAN-Number	9008905744525
Lifetime [h]	L80 B10 50 000



The values are rated values. Power and luminous flux are initially subject to a tolerance of +/- 10%. Colour temperature tolerance: +/- 150 K. The values apply to an ambient temperature of 25°C unless otherwise specified.