

AGON

305-0040680403006

AGON ROUND RECESSED SPOTLIGHT made of aluminium, black matt, similar to RAL 9005, beam 40°, light output direct, tilting 30°, without converter, max. 250mA, IP20



DRAWING

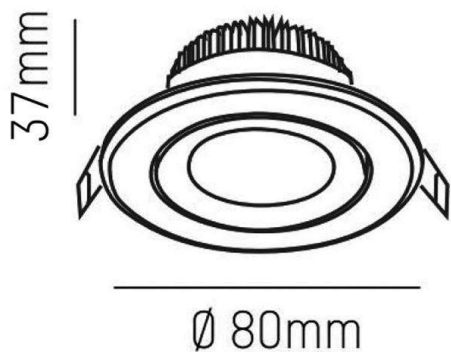

TECHNICAL DETAILS

Bulb type	LED 5W
Luminous flux [lm]	575
Current sec. [mA]	250
Colour temp. [K]	3000K
CRI	>80
Converter	without converter
Light output	direct
Beam angle [°]	40°
Voltage [V]	20 VDC
Material	aluminium
Height [mm]	37
Diameter [mm]	80
Ceiling cutout [mm]	68
Recess depth [mm]	70
IP protection class	IP20
Voltage class	protection cl. III
Net weight [kg]	0,16
Color lamp	black matt
RAL	9005
EAN-Number	9008905807077
Lifetime [h]	25 000

LIGHT DISTRIBUTION CURVE

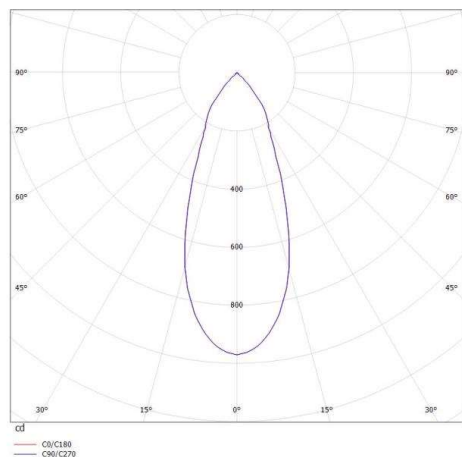

The values are rated values. Power and luminous flux are initially subject to a tolerance of +/- 10%. Colour temperature tolerance: +/- 150 K. The values apply to an ambient temperature of 25°C unless otherwise specified.